

Operation

Bottom Mounting



NO Normally Open

NC Normally Closed



Top Mounting



Typical connection to contactor

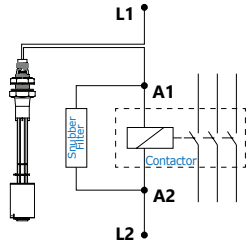

Switch **NO/NC - SPST**
Output **Contact ON/OFF**
Enclosure Rating **IP66**

! Never connect the sensor to a motor, pump, lamp or any other load over 20W. Always use a contactor or relay.

The sensors work in all voltage and current ranges displayed in the table below:

Operating Voltage	Max. Switching Power	Max. Switching Current	Peak Current
110Vac	20VA	0.2A	0.5A @20ms
220Vac	20VA	0.1A	0.5A @20ms
5Vdc	2.5W	0.5A	1A @20ms
12Vdc	5W	0.5A	1A @20ms
24Vdc	10W	0.5A	1A @20ms

24Vac: NOT recommended

Term of Warranty

For installations according to this guide:

01 (one) year warranty - **Incorrect installation cancels the warranty.** All sensors have been tested and approved during the manufacture process.

Chemical products require tests by the customer to verify compatibility with the constructive material of the sensor.

Liquids with ferrous particles require technical analysis: the sensor has magnetic component inside.

On datasheets.icos.us available technical specifications

+55 (15) 3032.9190

Electrical contact of sensors - Attention to install

Reed Switch 20W/VA: Protect the electrical contact of your sensor



Reed Switches are hermetically sealed contacts actuated by a magnetic field.

The life expectancy of a reed switch refers to a kind of load to be used. Reed Switches of the highest reliability are applied in our sensors, and their life expectancy can reach above two million operations. However, when they are switching lamps, inductive or capacitive loads, this number may decrease.

Switching Power

It is important to consider that the power specified by an electrical load is often referred to the permanent working state.

For higher power, use an auxiliary relay or contactor as recommended below.

Siemens 3RT1015 Contactor

Initial: 31.7VA
Rated: 5.1VA

Weg CW07 Mini Contactor*

Initial: 19.3VA
Rated: 5.5VA

Schneider CA2KN Contactor

Initial: 30VA
Rated: 4.5VA

Note: Reed Switches have reached over one million operations in tests with contactor and **K8*** snubber filter.

*On accessories.icos.us check models and prices of Filters and Mini Contactor

Level Switches

Manual: Models for Vertical Mounting



IMPORTANT!
YOU MUST CHECK BEFORE INSTALLATION

Connection with cable length **20 to 40 meters:**

For distances longer than 40m, use 24Vdc voltage (without the resistor)

Connection with: - Timing Relay - Frequency Inverter

For installation with Relay Coupler, use 4K7 10W resistor

Resistor **22R 5W** in series is required



Resistor **220R 5W** in series is required



Connection with Contactor 24Vdc

KD Filter is required



Connection with Contactor

Initial Power Rated Power

Should be less than **20W**

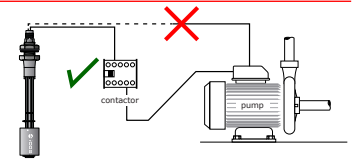

*For sale on accessories.icos.us

Questions? Call us **BEFORE** you install:

+55 (15) 3032.9190

levelsensor.icos.us | datasheets.icos.us | videos.icos.us

PROTECTION PROCEDURES BELOW DESCRIBED CAN IMPROVE THE REED SWITCH PERFORMANCE

Switching inductive loads

K8* Filter mounted in parallel with the coil of an AC contactor, increases the contact life.

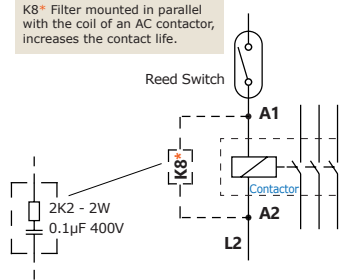

KD* Filter mounted in parallel with the coil of a DC relay, increases the contact life.

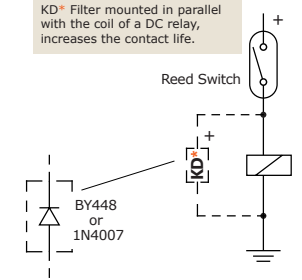

? Risk of failure (welding of the Reed Switch Contact) due to CAPACITANCE, which can occur depending on the distance and cable used in the connection to the contactor.

Connecting the sensor to a contactor in long distances, use resistor:

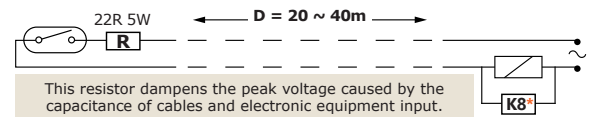

! Important: For distances **greater than 40m**, use 24Vdc voltage.

Connecting the sensor to an electronic equipment:

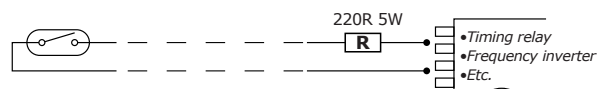

! Important: For installation with **relay coupler**, use 4K7 10W resistor.

For better sealing, the internal surface of the tank must be free of roughness.

Internal Vertical Mounting in Ø16mm Hole

With 150mm to 400mm Length + M12 Plug



Technical Specifications	
Material	PPA
Operating temperature range	-10°C to 90°C
Maximum operating pressure	2bar
Color	Black
Liquid minimum density (SG)	0.70
Sealing	NBR gasket
Output connection	M12 Plug

PPA Polyphthalamide:
For water, oil and fuel.

- Electrical contact: Reed Switch 20W/VA;
- Mounting: vertical internal in through hole with sealing gasket;
- NO or NC, by inverting the float position;
- Works on the top or bottom of the tank;
- 1 or 2 detection points;
- Stem length from 150mm to 400mm.

Models with 1 Detection Point and Electrical Output in M12 Plug (2 pins)

Technical Specifications	LE151-M12	LE201-M12	LE251-M12	LE301-M12	LE351-M12	LE401-M12
Stem length (h)	150mm	200mm	250mm	300mm	350mm	400mm

Models with 2 Detection Points and Electrical Output in M12 Plug (4 pins)

Technical Specifications	LE152-1-M12	LE202-1-M12	LE252-1-M12	LE302-1-M12	LE352-1-M12	LE402-1-M12
Stem length (h)	150mm	200mm	250mm	300mm	350mm	400mm
Distance between points (d)	63mm	113mm	163mm	213mm	263mm	313mm

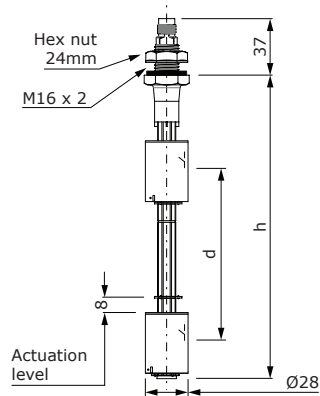
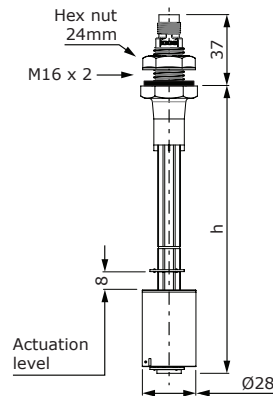

M12 Plug Sensors Installation

• 2 pins



Contact 1,3

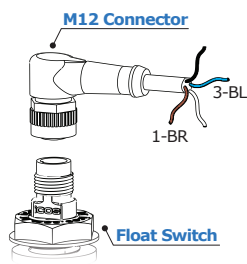
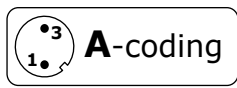

• 4 pins

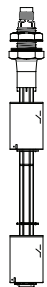

Upper contact 2,4

Bottom contact 1,3

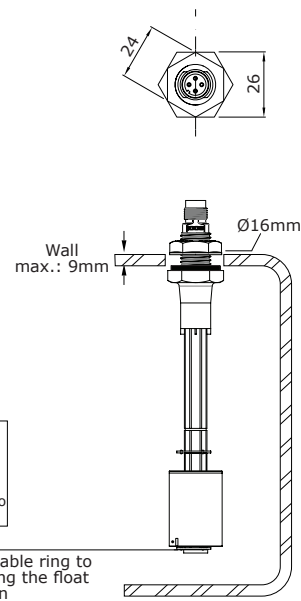
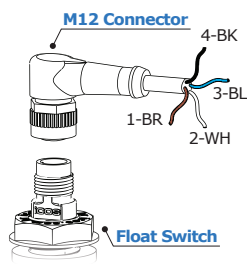
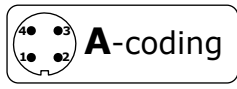

Dimensions in millimeters

On levelsensor.icos.us check models and prices of Level Switches

Flow Switches and Level Switches for liquids

Make it Easy